



FLUE GAS ANALYSER

GA-21 *plus*

Operating manual

10/1999

madur[®]
E L E C T R O N I C S

1 CONTENTS

1	CONTENTS.....	3
2	INTRODUCTION.....	5
2.1	USE OF THIS OPERATING MANUAL.....	5
2.2	SYMBOLS USED.....	5
3	MAINTENANCE.....	6
3.1	Gas sensors.....	6
3.2	Gas system.....	6
3.3	Battery.....	6
3.4	Service intervals.....	6
3.5	Errors during operation.....	6
3.6	Switching off after use.....	6
4	GENERAL INFORMATION.....	8
5	CONSTRUCTION.....	9
5.1	Elements of gas circuit.....	9
5.1.1	Gas probe with in-line filter.....	9
5.1.2	Gas pump.....	9
5.1.3	Gas chamber.....	9
5.2	Measurement system.....	10
5.2.1	Gas sensors.....	10
5.2.2	Ambient air temperature sensor.....	10
5.2.3	Flue gas temperature sensor.....	10
5.2.4	Gas chamber temperature sensor.....	10
5.2.5	Differential pressure sensor.....	11
5.2.6	Analogue inputs.....	11
5.3	Data input/output systems.....	12
5.3.1	Keyboard.....	12
5.3.2	Display.....	12
5.3.3	Printer.....	12
5.3.4	Interface RS 232C.....	12
5.4	Power supply.....	13
6	OPERATION.....	15
6.1	USE OF THE KEYBOARD.....	15
6.1.1	Description of the keys.....	15
6.1.2	Selecting Menu Options.....	15
6.1.3	Entering Numbers.....	16
6.1.4	Editing Text.....	16
6.2	Basic operating instructions.....	17
6.2.1	Setting-up the analyser.....	17
6.2.2	Switching on.....	17
6.2.3	Switching off/ Standby.....	17
6.2.4	Initial Calibration.....	17
6.2.5	Measurement Parameters.....	18
6.2.5.1	Fuel.....	18
6.2.5.2	Average Time.....	20
6.2.5.3	Reference Oxygen parameter.....	20
6.2.5.4	Boiler Parameter.....	20
6.2.5.5	Content of NO in NOx.....	21
6.3	Displaying the measurement results.....	21
6.3.1	Current Values.....	21
6.3.2	Averaged Values.....	22
6.3.3	The Averaging Process.....	22
6.4	Pressure/Draft Measurements.....	23
6.5	Soot (smoke) Measurement.....	23
6.6	Options.....	24

6.6.1	<i>Device Info</i>	25
6.6.2	<i>Sensors</i>	25
6.6.2.1	<i>CO range</i>	25
6.6.2.2	<i>O₂ cell calibration</i>	26
6.6.2.3	<i>External channels</i>	26
6.6.2.3.1	<i>Gas temperature sensor - TH GAS</i>	26
6.6.2.3.2	<i>Ambient temperature sensor - PT AMB</i>	27
6.6.2.3.3	<i>External thermocouple - T1 EXT</i>	27
6.6.2.3.4	<i>External resistance thermometer - T3 EXT</i>	27
6.6.2.3.5	<i>External Voltage/Current input - U/I EXT</i>	27
6.6.2.4	<i>Sensor calibration</i>	27
6.6.3	<i>Settings</i>	28
6.6.3.1	<i>Backlighting</i>	29
6.6.3.2	<i>Contrast</i>	29
6.6.3.3	<i>Clock</i>	29
6.6.3.4	<i>Printer</i>	30
6.6.3.5	<i>Language/country</i>	31
6.6.3.6	<i>Standard</i>	31
6.6.4	<i>Control list</i>	31
6.6.5	<i>madur Service</i>	32
6.7	<i>Storing of Results</i>	32
6.7.1	<i>Storing measurement reports</i>	33
6.7.1.1	<i>Report table</i>	33
6.7.1.2	<i>Header (Notice) editing</i>	34
6.7.1.3	<i>Erasing Reports</i>	35
6.7.2	<i>Continuous storing of results</i>	35
6.7.2.1	<i>Banks Table</i>	36
6.7.2.2	<i>Erasing Banks</i>	37
6.8	<i>Data-Logger</i>	37
6.9	<i>Printer</i>	38
6.9.1	<i>Printing the contents of a screen</i>	38
6.9.2	<i>Printing of all results</i>	38
7	BASIC PRINCIPLES OF CALCULATING RESULTS	40
7.1	<i>Quantities obtained from direct measurements (O₂, CO, NO, SO₂)</i>	40
7.2	<i>Calculating the concentration of carbon dioxide</i>	40
7.3	<i>Calculating the concentration of nitrogen oxides NO_x</i>	40
7.4	<i>Concentration of "undiluted" carbon monoxide CO_{undil}</i>	40
7.5	<i>Mass concentrations of gas components</i>	41
7.5.1	<i>Absolute mass concentration of gas components</i>	41
7.5.2	<i>Mass concentrations relative to the concentration of oxygen in combustion gases</i>	41
7.6	<i>Calculating combustion parameters</i>	42
7.7	<i>Fuel parameters</i>	43
7.8	<i>The influence of fuel parameters on the accuracy of result calculations</i>	45
8	BLOCK DIAGRAM	46
9	FRONT VIEW WITH KEYBOARD	47
10	MENU STRUCTURE	48
10.1	<i>Structure of the main menu</i>	48
10.2	<i>Structure of the menu STORE</i>	49
10.3	<i>Structure of the menu DATA</i>	49

2 INTRODUCTION

Congratulations on your purchase of the microprocessor-controlled flue gas analyser

madur GA-21 plus

It is a high quality instrument produced using the latest technical discoveries. The **GA-21 plus** is easy to use. You also have the possibility of using the extra capabilities of this analyser, of examining measurement results, checking service intervals and many others. Please read the operating manual carefully. It contains valuable tips and information for problem-free operation. Regular maintenance will help to keep your analyser ready for use at all times.

2.1 USE OF THIS OPERATING MANUAL

Keep this manual with the analyser **GA-21 plus**, and take it with you when carrying out measurements. Here is a short description of the sections of this manual.

3 MAINTENANCE

This section contains important information designed to keep your analyser working and to save you time and trouble.

4 GENERAL INFORMATION

This describes the most important characteristics of your new analyser.

5 CONSTRUCTION

A knowledge of the hardware of the analyser will help you to use the instrument correctly and to avoid unnecessary down-time.

6 OPERATION

This section explains the use of the analyser with detailed descriptions of the various functions. It is important to read the sections 6.1 and 6.2 first. The other sections can be read as and when required.

7 BASIC PRINCIPLES OF CALCULATING RESULTS

Here you will find all the necessary theory and formulas used in the calculations carried out by your analyser

2.2 SYMBOLS USED



- press the key shown



(5.6.1 Theme)

- Further information to this theme is available in the operating manual



-ATTENTION important information

Information or instructions marked so can be skipped if not immediately needed.

3 MAINTENANCE

3.1 Gas sensors

The following points are important for maximising the operational life of the cells and achieving measurements without errors:

- do not exceed the rated concentration;
- all the gas cells may react unpredictably to the presence of substances which are not usually found in flue gases. For this reason, the analyser may not be cleaned with chemical solvents. If organic solvents enter the gas chamber, the cells may become unstable or even suffer permanent damage;
- some cells require the presence of a bias voltage when not in use. Do not allow the battery to become fully discharged;
- do not switch the analyser off before the system is purged of remaining flue gas;
- store the analyser in a cool place to reduce the ageing of the cells.

3.2 Gas system

The gas system of the analyser is protected by a double in-line filter. The elements should be changed when necessary. Check the condensate traps regularly and empty them when needed.

3.3 Battery

The rechargeable battery used in the analyser is maintenance-free. An acoustic warning signal is given when the voltage drops below 11 V. The **GA-21 plus** will switch off automatically if the voltage should drop below 10.5 V. The analyser will operate for about 5 hours from the battery.



Some parts of the analyser draw current even when the device is switched off. If the analyser is not being used then the battery should be charged fully at least once a month.

3.4 Service intervals

The parameters of the electrochemical cells change with time, and therefore it is necessary to carry out a service periodically. This service should include re-calibration of the gas sensors using test gases. The recommended service interval is 800 operating hours or 6 months, whichever comes first. The analyser is fitted with an operating hour counter and automatically shows when a service is necessary.

The operating time and the number of hours until the next service are shown in SERVICE/DEVICE INFO.

3.5 Errors during operation

The analyser checks all circuitry continuously. Should an error become evident, then this is signalled acoustically and by the message "ERROR" on the screen. The error can be found shown on the screen OPTIONS/SERVICE/CONTROL LIST.

3.6 Switching off after use

The operating life of the electrochemical cells is dependent on the usage of the instrument. The wear and tear on the cells is greater when the cell is exposed to the gas for longer or the concentration is higher. The gas cell is hence "used up" during measurements.

For this reason, the analyser should not be switched off until all the gas tubing has been completely cleared of flue gases and the gas cells have been purged with fresh air for several minutes.

The **GA-21 plus** will not normally allow the instrument to be switched off if there are still traces of flue gas in the system. The analyser will continue to operate until the signals from the gas cells are nearly zero. This activity is shown by the message "VENTILATION REMOVE PROBE FROM FLUE".

The [**OFF**] key must be pressed twice to switch the instrument off completely. Pressing the key once will put the analyser in the standby mode and the instrument will remain in this mode until it is activated again by pressing "C" or switched off completely.



Certain conditions, such as strong electro-magnetic fields can cause the analyser to become "hung-up". The only solution to this problem is to switch the instrument off. It is, however, possible that the analyser will no longer react to the keyboard and can not be switched off.

Pressing the [OFF] key for a period of about three seconds will always switch the analyser off.

4 GENERAL INFORMATION

The **GA-21 plus** is a multi-functional flue gas analyser. Electrochemical sensors are used for the measurement of gas concentration. The instrument can be fitted with between 2 and 4 of these sensors. All analysers are fitted with O₂ and CO sensors, further gas cells must be chosen when the instrument is ordered.

The following description is based on an analyser containing 3 cells, the third one being an NO sensor.

- Oxygen, O₂
- Carbon monoxide CO
- Nitric oxide NO
- Carbon dioxide CO₂
- Nitrogen oxides NO_x

The first three gases (O₂, CO, NO) are measured directly using the electrochemical cells. The remaining components are calculated. The concentrations of oxygen and carbon dioxide are shown in percent. The concentrations of the remaining gases is shown as follows:

- volume concentration in [ppm]
- absolute mass concentration in [mg/m³]
- mass concentration relative to the oxygen content in [mg/m³]

In addition, the air inlet or ambient temperature and flue gas temperature are measured. Using the measured temperatures, gas concentrations and the known fuel parameters the analyser calculates a variety of combustion parameters such as Stack Loss - SL, Efficiency - η , Excess Air - λ , Loss through Incomplete Combustion - IL.

The **GA-21 plus** also measures differential pressure.. This can be used to measure the draught or pressure in the flue gas channel. The instrument is also equipped for the soot test according to Bacharach.

The analyser is also fitted as a 3 channel data logger, capable of measuring voltage or current together with temperature using thermocouples or thermoresistors.

The instrument can be used at a broad range of ambient temperatures (0 - 50°C). It is fitted with a rechargeable battery making it independent of the mains power supply.

Hence, the **GA-21 plus** is ideally suited for all those involved in the construction, maintenance and adjusting of heating systems.

The keyboard of the instrument can be wiped clean if necessary.

The **GA-21 plus** is controlled by a microprocessor. The easy-to-read LCD display, the comprehensive keyboard and the built-in printer allow the operator to communicate with the instrument easily and to document the measurements on the spot. The EEPROM memory used in the **GA-21 plus** allows large quantities of data to be stored without fear of data loss should the instrument be switched off or should the battery be accidentally run down. The **GA-21 plus** comes complete with programmed data for the 18 most common fuels. A further 10 fuels can be programmed by the operator to cover all eventualities.

The RS232C interface fitted to the **GA-21 plus** allows all stored data to be read for later treatment or the instrument can be used on-line with the computer.

5 CONSTRUCTION

Picture (page 46) shows a block diagram of the **GA-21 plus**.

Here is a description of the individual components.

5.1 Elements of gas circuit

5.1.1 Gas probe with in-line filter

The gas probe is used to extract the gases under investigation and to measure their temperature. The gas probe consists of two parts, the probe pipe with thermocouple (1) and the probe holder (2).

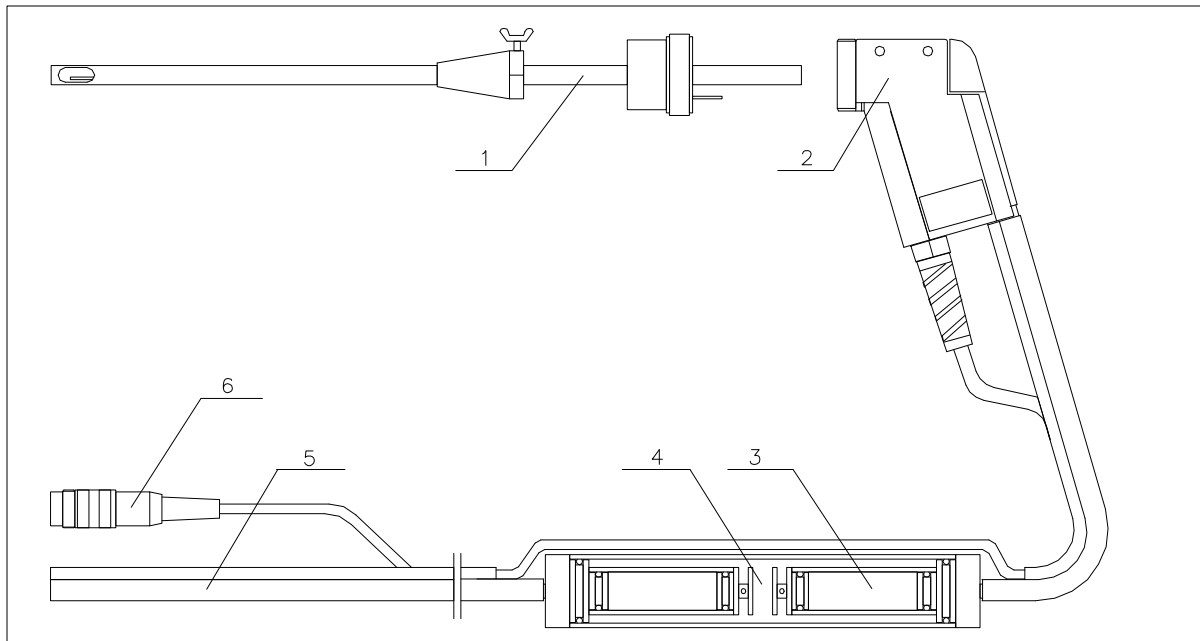

Picture 1 Gas probe with in-line filter

The probe pipe is typically supplied in one of four standard lengths: 150 mm, 300 mm, 750 mm and 1500 mm. As standard a Ni-CrNi thermocouple is used. The probe pipe is fitted with an anchor cone to simplify fixation in the flue gas channel.

The probe pipe is attached to the probe holder with a threaded connector.

The gas tubing in the **GA-21 plus** is protected from the dust and moisture present in the flue gases by a filter (4). The filter elements (3) should be changed when dirty to ensure a free flow of gas. The condensate should be removed from the condensate traps when necessary.

The plug (6) and hose end (5) are connected to the front plate of the analyser.

5.1.2 Gas pump

The internal gas pump draws the gas into the **GA-21 plus** and passes it through the gas chambers. The self-cleaning pump is a high quality item and is known to be extremely reliable.

The gas cells operate best with a flow rate of 90 l/h, which is set at the factory and is compensated automatically for flow restrictions or changes in battery voltage.

5.1.3 Gas chamber

The gas chamber is fitted with between two and four gas sensors. Oxygen and carbon monoxide sensors are fitted as standard equipment. The other cells are chosen when the instrument is ordered. The gas chamber of the **GA-21 plus** system is characterised by minimal dead capacity, which leads to low inertia of the analyser indications. In addition to the gas sensors, there is a temperature sensor placed in the chamber for temperature compensation of the sensors.

5.2 Measurement system

5.2.1 Gas sensors

The oxygen concentration is measured using an electrochemical cell. The sensor signal is directly proportional to the oxygen volume concentration. The oxygen sensor needs no calibration with standard gases - it is fully calibrated during the initial calibration when a point corresponding with the contents of oxygen in clean air (20.95%) is determined.

The toxic gases are also measured using electrochemical cells

Table 1 presents all the gas sensors available. Any of them can be used in **GA-21 plus** system.

To guarantee long-lasting, trouble-free function of electrochemical sensors the following points are important:

- the stated maximum measuring range of the sensor should not be exceeded.
- all the gas sensors can react unpredictably to certain chemicals which are not typical for combustion gas composition. For this reason, it is absolutely forbidden to wash the parts of the gas line with chemical solvents. The vapours from such solvents can get inside the gas chamber and result in destabilisation or even permanent damage of the gas sensors.
- the gas sensors are working even when the analyser is switched off - so the battery should never be disconnected or completely discharged.
- the analyser should not be switched off before all the flue gases have been removed from the analyser gas circuit.
- the sensor chamber must be kept dry.
- the switched off analyser should be kept in a cool place, which increases the lifetime of the gas sensors.

Gas	Cell type	Range [ppm]
O ₂	2FO	0 - 20.9 %
CO	A3E/D	0 - 4000
CO	3FD	0 - 20 000
CO	3M/F	0 - 10 %
NO	3NF/F	0 - 5 000
NO ₂	3NDH	0 - 1000
SO ₂	3SF	0 - 5000

Tab. 1 Available measuring cells and ranges

5.2.2 Ambient air temperature sensor

The ambient temperature is measured by the analyser for use in some of the calculations carried out, such as Stack Loss. This can be carried out either by the temperature compensation sensor built into the plug of the probe holder (INT) or the external connector T3 (EXT). The temperature sensor is chosen under the suboption **OPTIONS / SENSORS / ANALOGUE INPUTS**.

5.2.3 Flue gas temperature sensor

The flue gas temperature sensor is situated in the gas probe pipe and plugged into the *PROBE* socket on the front panel of the analyser. This sensor is a NiCr-Ni thermocouple in the standard probe version. The range of such a thermocouple is 50-800°C in the standard version (1100°C available optionally). A special gas probe with PtRh-Pt thermocouple can also be used, with a range up to 1600°C. Proper flue gas temperature measurement is the most important factor for correct calculation of the chimney loss and other heat engineering results.

5.2.4 Gas chamber temperature sensor

To compensate for temperature drift of the gas cells, the temperature of the gas chamber is constantly monitored.

5.2.5 Differential pressure sensor

The GA-21 *plus* is fitted with a precise semiconductor differential pressure sensor. Stubs marked +/- *PRESSURE* situated on the left side of the front panel are used to measure pressure. Negative pressure in flue gas channel (chimney draught) can be measured with the one stub only; differential pressure measurement is possible using both stubs. The measuring range of the pressure sensor is +/-50 hPa.

5.2.6 Analogue inputs

The three analogue inputs installed can be used to measure voltage or current on two channels (U and I), temperature using a thermocouple (T1 EXT) and temperature using a thermistor (T3 EXT). The values measured can be viewed on the screen or stored in the EEPROM memory.

Tables 2 and 3 show the technical data for the analogue inputs.

Parameter	U	I
Range	-10 V ÷ 10 V	-10 mA ÷ 10 mA
Input resistance	100 kΩ	100 Ω
Definition	10 mV	10 μA

Tab. 2 Parameters for current and voltage channels

Parameter	Thermocouple	Thermistor
Range	Ni-CrNi: 0 ÷ 1300 °C Pt-RhPt: 0 ÷ 1600 °C Fe-CuNi: 0 ÷ 700 °C	Pt 100: 0 ÷ 200 °C Pt 500: 0 ÷ 100 °C
Resolution	1 °C	1 °C

Tab. 3 Parameters for temperature channels

The analogue inputs are connected to the sockets U/I1 and TEMP1 on the front of the analyser. Table 4 shows the use of the pins in the sockets (seen from the socket side).

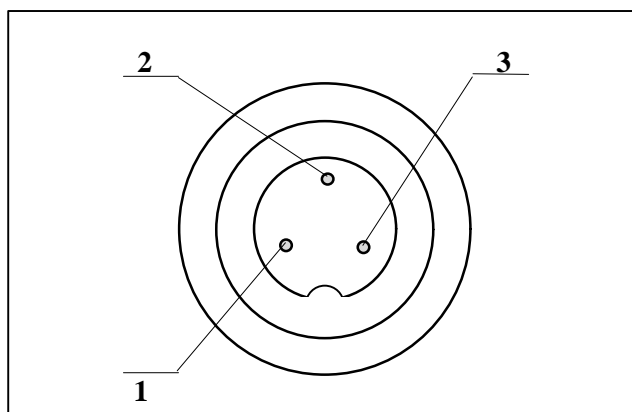

Picture 2 Socket for analogue inputs

SOCKET	Pin No.	Signal	Description
	1	GND	common I1(-), U1(-)*
U/I1	2	I1+	current I1 (+)
	3	U1+	voltage U1 (+)
	1	T3 EXT +	Thermistor 1(+)
TEMP. 1	2	T1 EXT +	Thermocouple 1(+)
	3	GND	common (-)*

* - The negative sides are all connected to ground

Tab. 4 Connections to analogue inputs

5.3 Data input/output systems

5.3.1 Keyboard

A film keyboard is used in the **GA-21 plus** analyser which is durable, washable and highly resistant to external agents. The keys are modern membrane keys with perceptible stroke.

Each press of a key is accompanied by an acoustic signal. The keyboard is shown in picture B (page 47) and consists of the following elements:

PROBE - Socket for the electrical connection of the probe holder

GAS - Connector for the gas hose

PRESSURE +/- - Connectors for the differential pressure sensor

RS 232 C - Socket for the RS232C cable

TEMP. 1 - Socket for the temperature channels 1 & 2

U/I 1 - Socket for the current/voltage channels

Function keys -

STORE	DATA	MENU	ENTER
-------	------	------	-------

Arrow keys -

←	→	↑	↓
---	---	---	---

Printer keys -

PRINT	PAPER
-------	-------

ON/OFF keys -

ON	OFF
----	-----

numerals -

0	to	9	.	C
---	----	---	---	---

5.3.2 Display

The **GA-21 plus** has a LCD display with graphic capabilities. To improve the read-out quality, contrast regulation for the display and backlighting are used. Measurement results, calculation results, diagrams, text information, menu options and others appear on the display.

5.3.3 Printer

The **GA-21 plus** is fitted with an EPSON dot matrix printer capable of printing the data as graphic or in the form of tables. All the screens seen on the analyser may be printed.

Printing speed is about 2.5 lines per second. The printer uses normal paper, 57 mm wide.

5.3.4 Interface RS 232C

The **GA-21 plus** is fitted with a serial RS232C interface. The socket is mounted on the front of the instrument and marked RS232C. The interface allows the **GA-21 plus** to communicate with a PC and the software WINFGA is available for carrying out extensive analysis of the stored results.

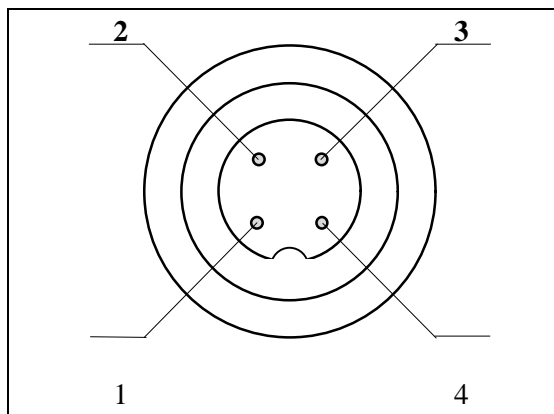

Picture 3 RS 232 socket

Picture 3 shows the pins of the interface socket seen from the front. Table 5 shows the connections to the socket.

SOCKET	Pin No.	Signal	DESCRIPTION
	1	RTS	control
RS 232	2	RxD	Receive Data - RS 232C
	3	GND	ground
	4	TXD	Transmit Data - RS 232C

Tab. 5 RS232 connections

Picture 4 shows the correct connection between the **GA-21 plus** and a PC.

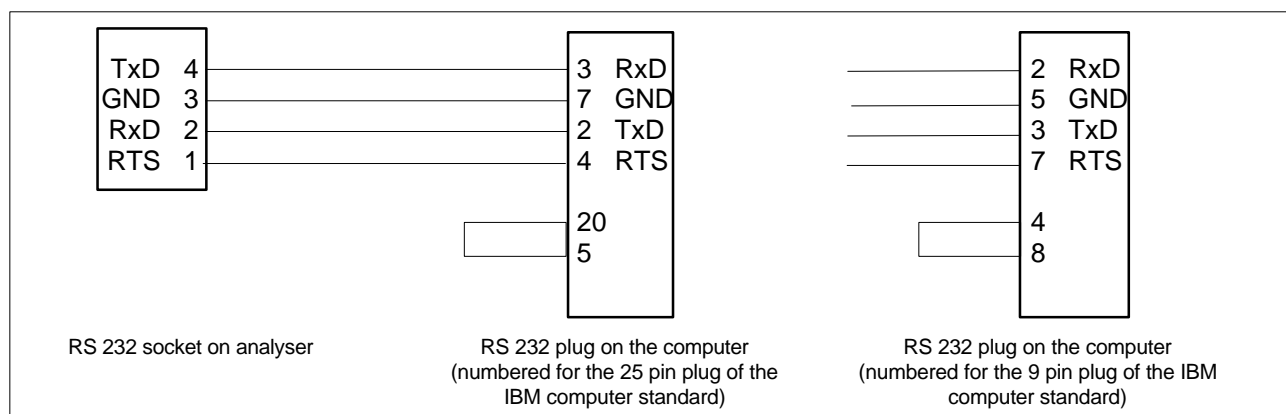

Picture 4

5.4 Power supply

The **GA-21 plus** can be used with mains power supply or be operated from the internal battery. A soot test can only be carried out when the mains supply is connected, otherwise the heating in the probe holder will not function. The mains cable is attached to the socket on the left of the keyboard. Switching the mains supply on or off when the instrument is in operation is not recommended. The analyser switches automatically to the internal battery when the mains supply is disconnected. The LED on the front panel shows which power supply is in use.

- Red** - analyser is switched on and supplied from the battery. Mains supply not present.
- Green** - analyser switched off and mains supply present. The battery is charging.
- Orange** - analyser switched on and mains supply present. The battery is charging.

The maintenance-free 12 V battery used has a capacity of 2 Ah. A fully charged battery will power the instrument for about five hours.

Should the battery voltage drop below 11 V, then this is signalled with three acoustic warnings and blinking of the LED on the front panel. The message *ERROR* appears at the top of the screen and the *CONTROL LIST* contains the line *BATT LOW*.

The instrument switches off automatically if the battery voltage drops below 10.5 V.

The battery is charged by connecting the instrument to the mains power supply.

The state of charge can be seen during the initial calibration or read from the screen *DEVICE INFO*:

6 OPERATION

6.1 USE OF THE KEYBOARD

6.1.1 Description of the keys

STORE	- Switches to the STORE menu
DATA	- Switches to the first results screen. From the current results, the use of this key switches between MEASURE and HOLD.
MENU	- Switches to the MAIN MENU
ENTER	- Confirms entries and switches options
0 to 9	- Alphanumeric keyboard for entering data and for fast movement between MENU options
.	- Decimal point when entering data. If used when the screen is showing RESULTS, this key switches the zoom function on or off.
PRINT	- starts a print-out
PAPER	- moves the paper forward one line
ON	- switches the analyser on
OFF	- switches the analyser to stand-by or off
←	- moves one step backwards in the menu
→	- moves one step forward in the menu or, during editing, moves the cursor one space to the right
↑ and ↓	- move the cursor vertically in the menu

6.1.2 Selecting Menu Options





The menu structure is shown at the end of the manual. The various displayed menus are leading the user through the structure.

The following picture shows an (not existing) screen, which explains the different types of existing lines.

←	PARAMETER	Title line
1	FUEL →	Option line
2	STORE	Command line
3	O2R 11 %	Data line
4	FOOTER YES	Switch line

Here is an explanation of the movement between the various menu options:







↑ and ↓	- move the cursor vertically in the menu
←	- is the cursor (←) on the left side of the Title line , the key moves one step backwards in the menu

-  - is the cursor (➡) on the right side of the **Option line** or the **Title line**, the key leads to the displayed **Option** .
-  - executes the displayed function (starts data storage for example), in the **Command line**
starts or ends the respective edit function (setting the average time for example) in the **Data line**
switches (i.e. YES/NO) in the **Switch line**
-  to  - **for fast movement between MENU options**

If a displayed line carries a function, then there will be a number (1 to 9) on the left side of the line. Press the number of the option you want to select, and the cursor (beam) will "jump" to the selected line. If number 4 is pressed in the above demo screen the beam would move to **FOOTER**.











6.1.3 Entering Numbers

Numbers are edited as follows:

-  to   - digital keys enter corresponding numbers
-  and  - move the cursor within the line
-  - erases whole number (zero on each position)
-  - Confirms and ends the entry

6.1.4 Editing Text

Text is edited as follows:

-  - switches the keyboard into either digital or alphabetical mode. When in digital mode the cursor has a block form on the screen, in the alphabetical mode it has the shape of an underlining
-  and  - move the cursor within the text line
-  - erases the whole text line
-  to   - the alphanumeric keys enter numbers in digital mode or letters in alphabetical mode. Each key has a three letter designation. The first press enters the first letter, the next presses the second and the third letter. Key presses in alphabetical mode does not move the cursor.
-  - (**SPACE**) prints 0 number in digital and the space character in alphabetical mode. The space moves all the next characters one position to the right.
-  - (**DEL**) erases the character above cursor position. This moves all the following characters one position to the left.
-  - ends the entering of a text (if only one line is edited - e.g. the name of a fuel) or moves the cursor down to the next line (if there are several lines in the edited text - e.g. the report header)
-  - end the editing of a header or footer - it enables the storage of edited text. If you do not need to store the contents of header or footer you should leave the screen by pressing the MENU key.

6.2 Basic operating instructions

6.2.1 Setting-up the analyser

Connect the components of the analyser system

- Attach the hose to the connector GAS. The plug from the probe holder connects to the socket PROBE..
- Attach the outlet hose from the filter to the connector INLET
- Ensure that the gas flow from the base of the analyser is free of obstructions.

6.2.2 Switching on

Before use, the condition of the analyser should be checked:

- Check the filter elements. Clean or replace as necessary.
- Check the state of charge of the battery if the analyser is to be operated from the internal battery. This is carried out by switching on and reading the battery voltage or charge from the initial screen, or from the screen MENU/OPTIONS/DEVICE INFO.

6.2.3 Switching off / Standby

Pressing the key [*OFF*] once will switch the analyser to the *STANDBY* mode.

In *STANDBY* mode the power consumption is drastically reduced. Amongst others the pump and the backlight are switched off. Only the sensors remain supplied to be ready to operate immediately after the instrument is switched on again.

The analyser does not switch to *STANDBY* mode if [*OFF*] is pressed in case:

- the key is being pressed during Initial Calibration. In that case the instrument realises the action, but will switch to *STANDBY* only after the calibration is finished.
- the key is being pressed while there is still a high gas concentration detected in the gas chamber. In this case the instrument will automatically switch to *FLOODING WITH AMBIENT AIR* mode and switch to den *STANDBY* later on.

The following screen is shown in the *STANDBY* mode.

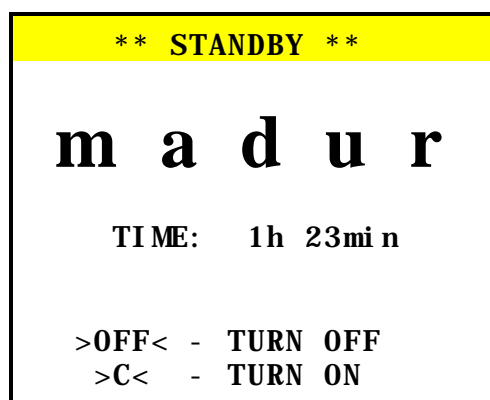

By pressing [*OFF*] the instrument can be switched off completely. If [*C*] is pressed the instrument switches ON again. If the instrument is in *STANDBY* mode for more than 8.5 hours it switches off automatically. It is highly recommended to carry out a calibration of the oxygen sensor when re-activating the instrument.

6.2.4 Initial Calibration

After the instrument is switched on it carries out an initial calibration for 2 minutes.



Make sure the probe is not in the stack during the initial calibration

Initial calibration is of basic importance for measurement correctness and it must not be interrupted before it is finished automatically.

During this time the Oxygen sensor is calibrated to 20,95% in ambient air, and the other sensors (CO, NO,...) will be zeroed.

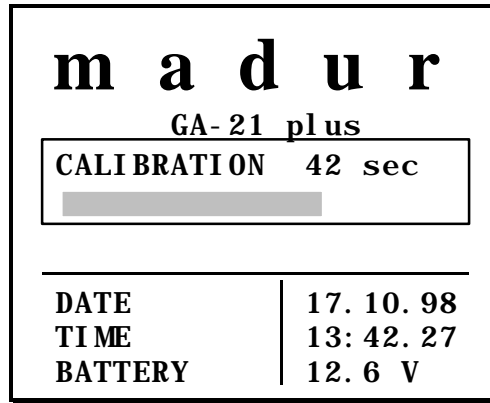

6.2.5 Measurement Parameters

Directly after the calibration is finished the option **PARAMETER** is displayed for control reasons or in case changes need to be done. Usually the option is selected as follows:

- selects the **MENU** screen

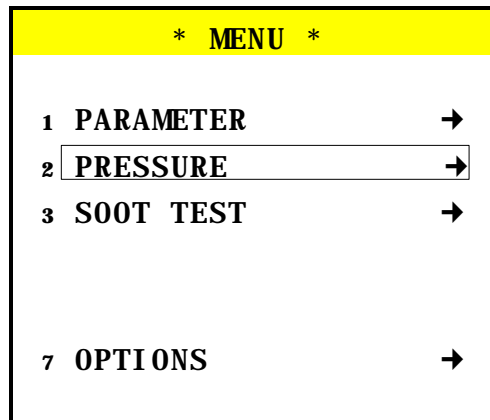

and - move the cursor to the **PARAMETER** option

- select the option. The following screen will appear:

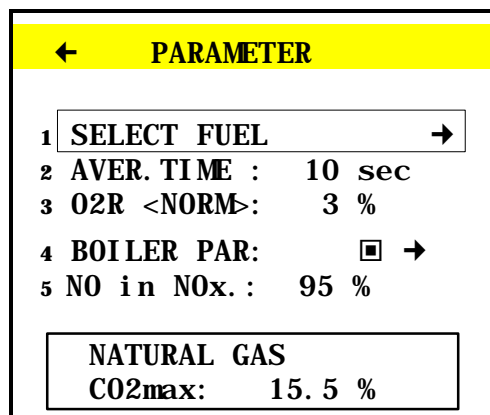

6.2.5.1 Fuel

This option enables the selection of a fuel (if necessary), or the programming of a customised fuel. From **PARAMETER** you move to the option as follows::

and - move the cursor to **FUEL**

- choose **SELECT FUEL**
 and - move the cursor to the desired fuel
 - confirm the selection - an asterix (*) will appear on the left side

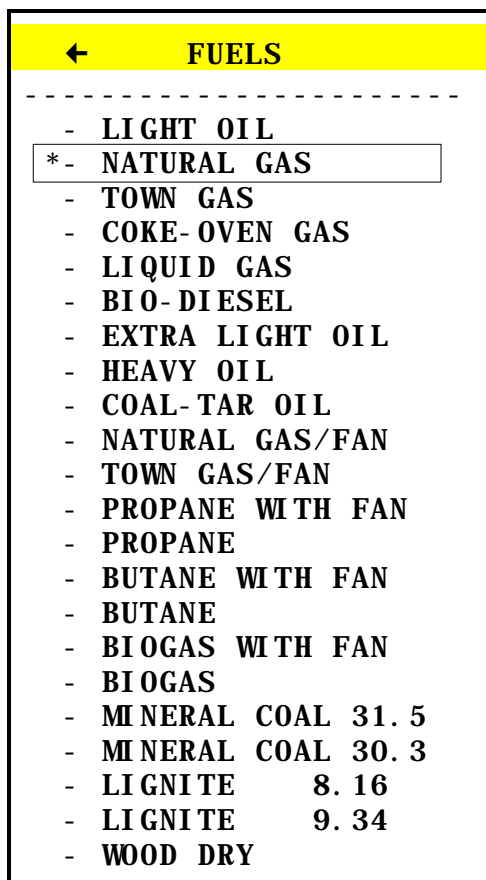



Each fuel of this screen is defined through various parameters. To view them proceed as follows:

- and - move the cursor to the desired fuel
 - displays the fuel parameters , or gives the opportunity to enter fuel data for the programmable fuels.
 - back to option **FUEL**

The following screen appears. The already defined fuels can only be viewed. For the user definable fuels all parameters can be programmed.

The variables are as follows:

- NAME** - Name of the fuel
- CO2max** - the maximum concentration of CO₂ (for complete combustion, O₂=0 %)
- A1, B** - factors for Siegert's formula  (Sec. 7.7)
- ALPHA** - fuel specific parameter  (Sec. 7.7)
- O₂R** - reference oxygen
- V_{atr}** - volume of the flue gas at perfect combustion of the fuel
- H_u** - Heating value of the fuel
- UNIT** - unit in which the fuel is measured

← DEFINE FUEL		
1	NAME	
2	CO2max [%]	15.8
3	A1	0.500
4	B	0.007
5	ALPHA	33
6	O2R [%]	3
7	VAttr [m3/l]	5
8	Hu [m3/l]	7
9	UNIT	kg

6.2.5.2 Average Time

To select the average time proceed as follows:

and - move the cursor to *Average Time*

- select Average Time edition

to - select the time (1 to 60)

- confirm the number

and - select **min** or **sec**

- confirm the selection

6.2.5.3 Reference Oxygen parameter

To select the reference oxygen proceed as follows:

and - move the cursor to *O2R*

- switches between a pre-programmed standard value *<NORM>* and a free programmable one, called manual value.

to - if "manual" was selected, a number from 1 to 20 can be entered

- confirms and ends editing

6.2.5.4 Boiler Parameter

This option enables the user to have relevant boiler parameters printed on the Protocol printout for exact documentation.

and - move the cursor to *BOILER-PARAMETER*

- select with *YES/NO* whether or not the Boiler Parameters shall appear on the printout, respectively being stored in a Protocol

- if YES was selected, this key moves to the Boiler Parameter menu. The boiler parameters can be entered in the screen shown below:

← BOILER PARAMETER		
1	POWER :	22.4 kW
2	CONSUM :	34.5 m ³ /h
3	TEMP. :	350 °C

- Boiler power shown in kW
- Boiler consumption in m³/h or kg/h
- Boiler temperature in °C

6.2.5.5 Content of NO in NO_x

The expected content of NO in NO_x is entered here in percent. The value is, according to experience, pre-set to 95%. Special applications may require different settings. For such applications the factor can be set in a range of 40% to 100%.

To change the calculation parameter proceed as shown below:

- and - move the cursor to *NO in NO_x*
- select editing
- to - enter the desired value from 40 to 100 (%)
- confirms the entered value and stores it

6.3 Displaying the measurement results

Select the measurement screen by pressing **DATA**. The measurement results are displayed on three screens, either as current values or as averaged values.

6.3.1 Current Values

- select the first screen

CURRENT VALUES →		
NATURAL GAS		
TEMP. GAS	357	°C
TEMP. AMBIENT	23	°C
O ₂	5.31	%
CO ₂	11.24	%
CO	438	ppm
NO	128	ppm
SL	24	%
ETA	76	%
LAMBDA	1.73	

- and - move backward or forward to select a screen

← CURRENT VALUES →		
GAS	VOL. [ppm]	Rel. 3% O ₂
CO	438	511
CO _u	475	624
NO	128	194
NO _x	185	366

← CURRENT VALUES		
TEMP1 EXT.	57	°C
TEMP2 EXT.	23	°C
U/I 1 EXT.	1.25	V
PRESSURE	7.12	hPa
SOOT	3	

ENTER

- switches between *AVERAGED VALUES* and *CURRENT VALUES*

DATA

- switches On/Off the *HOLD* function ("freezing" the current values)

6.3.2 Averaged Values



(Sec. 6.2.5.2) - select the desired averaging time

DATA

- select the screen. The title line has to read *AVERAGED VALUES*

and



- backward or forward to select one of three screens

ENTER

- switches between *AVERAGED VALUES* and *CURRENT VALUES*

C

- the display on the *AVERAGED VALUES* screen gets "synchronised" (a row of strokes appears instead of the values) and a new averaging session starts. The measured results are displayed after the whole cycle is finished.

DATA

- switches On/Off the *HOLD* function ("freezing" the current values)

If a continuous storage recording is taking place the analyser won't synchronise the averaging process (not to interfere with the continuity of storage)

6.3.3 The Averaging Process

The analyser is capable to display all results, measured or calculated, either as current value or as averaged value. The averaging time can be selected in a range of 10 seconds to 60 minutes. If a time of 1 min was set, the averaged results over that time would be shown on the display. During the start of the averaging process a row of strokes appears on the screen, since there are no results to display.

If measurement parameters are changed during the averaging process, the averaging cycle has to be re-started. In case the data storage is activated it is stopped as well.

The following incidents cause an interruption of the averaging cycle.

- change of averaging time
- change of reference Oxygen
- change of fuel
- switching the instrument to *STANDBY* mode

6.4 Pressure/Draft Measurements

It is possible to measure differential pressure with the **GA-21 plus**. To do so the stubs **PRESSURE (-)** and **(+)** on the front plate are used. The measurement is performed as follows:

- select the main MENU
- and - move the cursor to PRESSURE
- select the option. The following screen appears

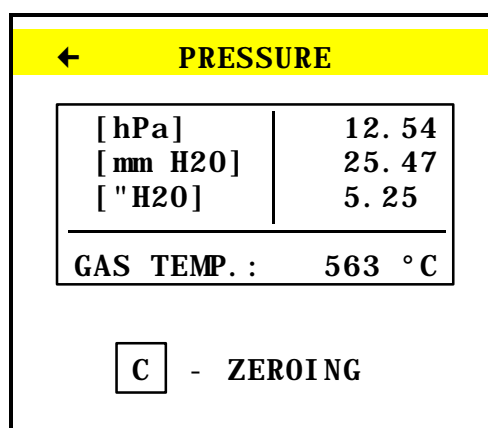

The current pressure and gas temperature are displayed on the screen. The last line shows the command ZEROING. By pressing this key the sensor is set to zero, e.g. the current value will be taken as zero value.. Please be aware that the sensor has to be zeroed before the measurement.

- ZEROING the sensor

Connect end of the sample hose to the **PRESSURE(+)** stub. The screen will display the measured pressure and the measured gas temperature.

- leaves the option. The displayed value will be stored until a new one is stored or either a printout of the measured values is performed or they are stored as a report.

6.5 Soot (smoke) Measurement

To perform a soot test it is essential to prevent the flue gas from condensing on the filter. Therefore it is necessary to use a heated probe holder. It is only possible to perform a soot test if the instrument is connected to the mains.

The soot test is done by means of the Bacharach comparison method..

- select the main MENU
- and - move the cursor to **SOOT TEST**
- select the option, the pump is switched off and the following screen appears:

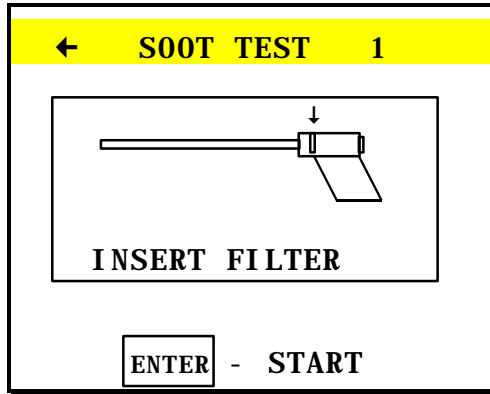

Insert the soot filter in the slit of the heated probe holder, and place the probe in the stack.

ENTER

- starts the soot measurement. The pump is switched on and sucks in 60 s (according to TÜV) the required volume of 1.63 +/-0.07 l

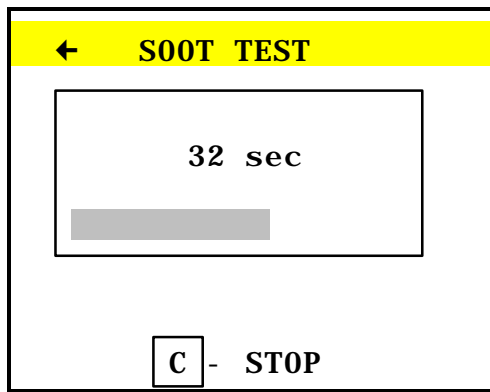

C

- stops the soot test

After the soot test the filter is compared with a scale, and the evaluated soot number is entered.

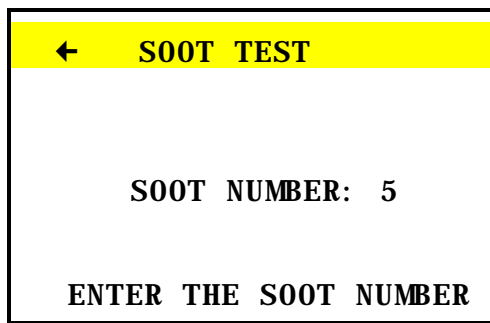

0 to **9**

- enter the detected soot number

ENTER

- confirm the soot number

The stored soot number remains stored until a new one is entered, or either a printout of the measured values is performed, or they are stored in a report.

6.6 Options

The *OPTIONS* can be reached from the *MENU* as follows:

↑ and **↓**



- move the cursor to *OPTIONS*

→

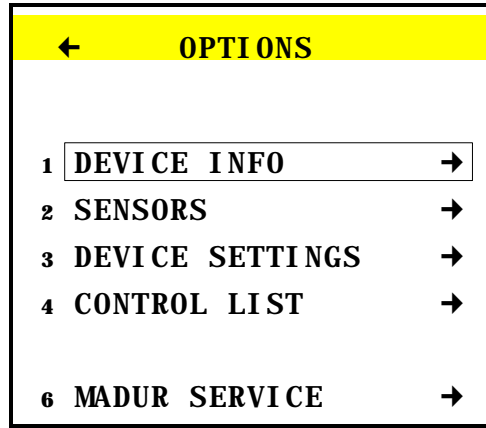
- select option. The following screen appears



6.6.1 Device Info

 and  - move the cursor to *DEVICE INFO*

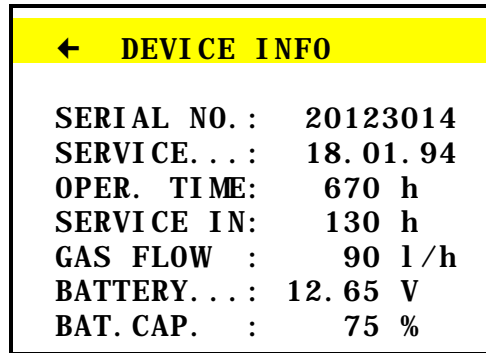

 - select option.



The *DEVICE INFO* screen shows the serial no. of the instrument, the date of the last service, the operating time, the time until the next service, the speed of the sucked flue gas , the battery charge, the battery capacity and whether or not the communication with the WINFGA software is locked.

6.6.2 Sensors

select the option *SENSORS* from the screen *OPTIONS* as follows:

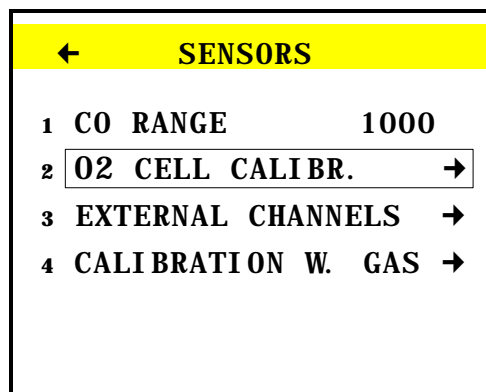

 and  - move the cursor to *SENSORS*

 - select the option. The following screen appears



6.6.2.1 CO range

If the concentration of CO in the gas stream exceeds the limit set here, then the cell is automatically purged with fresh air. This limit can be altered as follows:

 and  - move cursor to the line *CO RANGE*

- ENTER - start editing of the value
- 0 bis 9 - enter a number between 0 and 20000 ppm
- ENTER - close the option

6.6.2.2 O₂ cell calibration

To increase the accuracy of the O₂ sensor during measurements over a longer period of time the **GA-21 plus** has the capability of calibrating the sensor with ambient air.

Take the probe out of the stack !

- ↑ and ↓ - move the cursor to *O₂ cell calibration*
- - select the option. The following screen appears

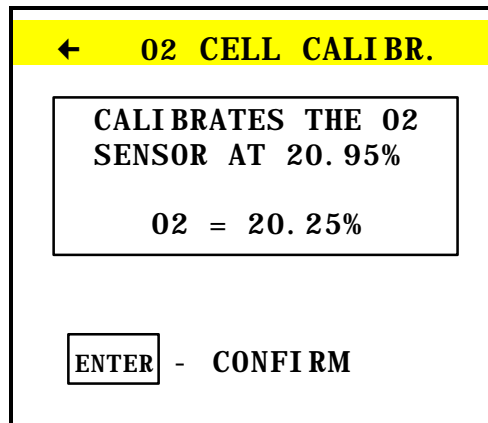

- ENTER - confirms the calibration

6.6.2.3 External channels

Get from the screen *SENSORS* to the option *EXTERNAL CHANNELS* as follows:

- ↑ and ↓ - move the cursor to *EXTERNAL CHANNELS*
- - select option.

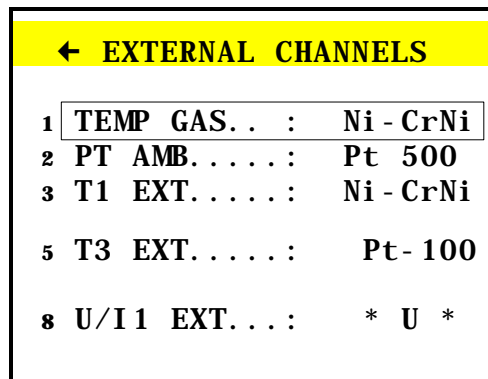

- ↑ and ↓ - move the cursor to the line to be changed
- ENTER - change the setting

6.6.2.3.1 Gas temperature sensor - TH GAS

- ENTER - default setting: *NiCr-Ni*. For special applications (temperatures up to +1600°C) the setting can be changed to *PtRh-Pt* thermocouple. Of course that would need the use of the respective thermocouple as well.

6.6.2.3.2 Ambient temperature sensor - PT AMB.

ENTER

- default setting: *Pt 500*. The ambient temperature can either be measured with an internal sensor placed in the probe plug (*Pt500*), or with an external sensor (*Pt500*), connected to the *TEMP (T3 EXT.)* socket.

6.6.2.3.3 External thermocouple - T1 EXT

ENTER

- Select the desired temperature sensor. The *T1 EXT* input can be defined as a *Ni-CrNi*, *Pt-RhPt* or *Fe-CuNi* thermocouple

6.6.2.3.4 External resistance thermometer - T3 EXT

ENTER

- Select the desired temperature sensor. The input *T3 EXT* can be defined as a *Pt100*, *Pt500* or *KTY-2k* thermistor.

6.6.2.3.5 External Voltage/Current input - U/I1 EXT

Select the desired signal in the respective line by pressing [ENTER]

ENTER

- Select the desired input signal . The socket *U/I1* can be used to measure either current (0-10 mA) or voltage (-10V - +10V).

6.6.2.4 Sensor calibration

Except for O₂ every electrochemical sensor needs to be calibrated with calibration gas. To calibrate the sensors they are fed one by one with calibration gas of a known concentration. After a few minutes the sensor supplies a stabilised signal which can be stored as calibration value. The order of calibration does not effect the calibration.



Any calibration screen value change is followed by loss of the original calibration settings. Thus the CALIBRATION option should be selected only when it is to be carried out.

The standard gas concentration should be similar to that usually met during measurement and it should not be less than 10% of the required measuring range of a given sensor

The time the sensor is fed with standard gas should not be less than 4 min. After each calibration the sensors should be flooded with ambient air for at least 15 minutes.

Calibration procedure

↑

and

↓

- move the cursor to *CALIBRATION W. GAS*

→

- select the option

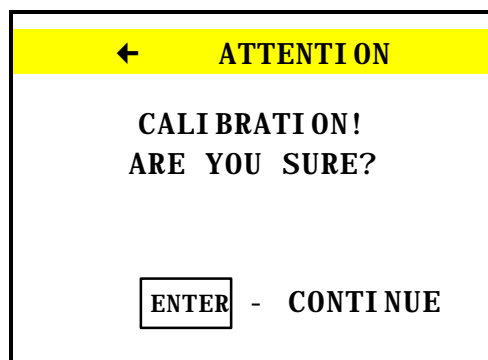



ENTER

- carry on with the calibration

←

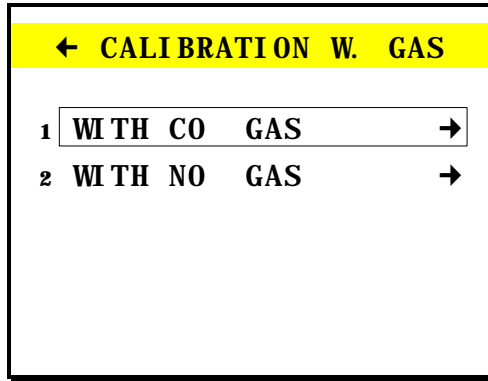
- abort the calibration, move back to *SENSORS*





 and  - move the cursor to the sensor to be calibrated

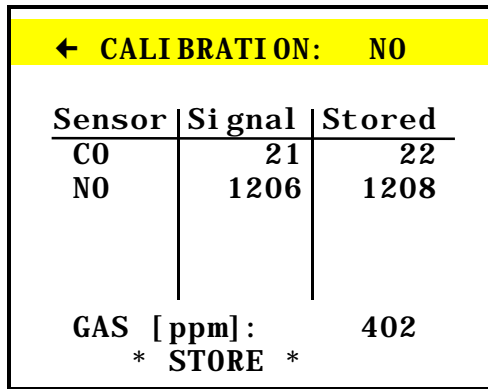

 - select the gas

The individual lines have the following meanings:

- SIGNAL** -the actual signal, supplied by the sensor
- STORED** -the signal value stored at the last calibration
- GAS [ppm]** -the concentration of the standard gas



 - in the **GAS [ppm]** line, starts editing of the standard gas concentration

 to  - enter the concentration of the standard gas [ppm] in the line **GAS [ppm]**

 - in the **GAS [ppm]** line. Confirm standard gas editing.

Supply the instrument with standard gas for about 4 min.



 - in the **STORE** line, as soon as the value has stabilised, stores the measured value as calibration value.

Disconnect the standard gas and flood the instrument for at least 15 min with ambient air

 - return to select the next gas, or end the calibration

6.6.3 Settings

This option allows the user to adjust some of the standard settings.

 and  - move the cursor to the option **SETTINGS**

 - select the option

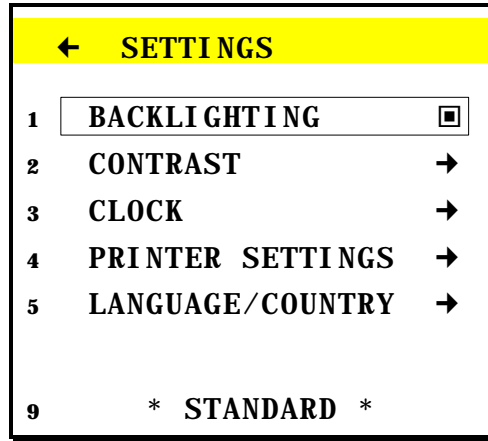

6.6.3.1 Backlighting



- pressing the key switches the *BACKLIGHTING* on and off

6.6.3.2 Contrast



and



- move the cursor to *CONTRAST*



- select option

Follow the explanations on the screen to adjust the contrast

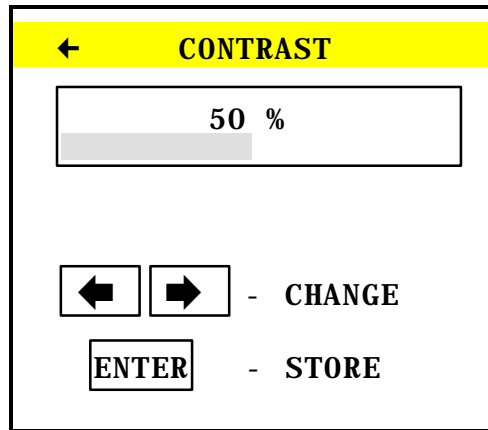

6.6.3.3 Clock

This option allows the internal clock to be adjusted.



and



- move the cursor to *CLOCK*



- select option

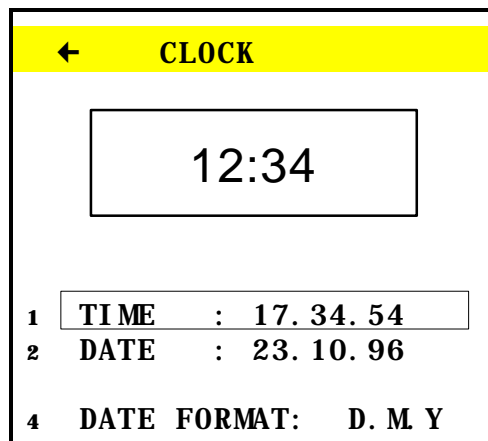

- and - move the cursor to desired line
 - opens editing
 to - set date and time. They are entered in the sequence *TIME - HH:MM.SS* and *DATE* as given by the format line below.
 - confirms settings

6.6.3.4 Printer

This option allows the printer (printout) settings to be defined.

- and - move the cursor to **PRINTER SETTINGS**
 - select option

← PRINTER SETTINGS

1	SHORT FORM	:	<input type="checkbox"/>
2	AUTOM. PRINTOUT:	:	<input type="checkbox"/>
3	NO. OF COPIES	:	1
4	ADDRESS NO.	:	3

- Address -

*4 - lines
freely editable*

SHORT FORM

- switches between **YES/NO**. If the option is activated, then a print-out of the current values will show only the volume concentrations of the gases, not the mass concentrations in mg/m³. A stored report will still have all the information as usual.

AUTOMATIC PRINTOUT

- switches between **YES/NO**. If the option is activated, automatic printouts will be carried out according to the programmed average time, provided the time is not less than 2 min. If the average time is shorter than 2 min. only one printout will be performed.

NUMBER OF COPIES

- switches between *1/2/3*.



ADDRESS NO.

The instrument can store up to 50 addresses. Number one is already stored and can not be changed. If address 0 is selected, no address will be on the printout. The addresses 2 to 50 are freely programmable.

- activates address selection
 and - select the address(number)
 - confirms the selection.



ENTER ADDRESS

This option allows the user to edit the address(es) under the number defined in the above option **ADDRESS NO**. An address can consist of up to 4 lines of 20 characters.



-  - select option. Edit the address according to the on-screen instructions.
-  - stores the edited address as displayed.
-  - by pressing this key the edit-screen is left without storing changes if the cursor is positioned in the upper left corner of the screen.

6.6.3.5 Language/country

The instrument enables the user to select between 2 languages.

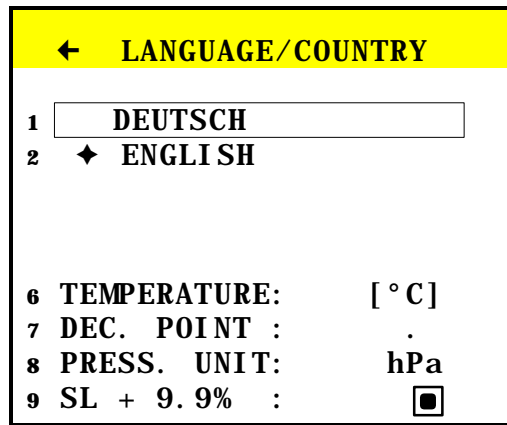
-  and  - move the cursor to *LANGUAGE/COUNTRY*
-  - select option



-  and  - move the cursor to the selected language
-  - confirms the selection

The other lines are specific settings for various countries.



-  - switches the options

6.6.3.6 Standard

-  - sets the instrument to default settings

6.6.4 Control list

The option *CONTROL LIST* displays a similar list to the one above. The list shows which subassembly functions correctly (OK), or which is defective (ERROR).

-  and  - move the cursor to *CONTROL LIST*
-  - select option

← CONTROL LIST	
CO I	: OK
CO II	: OK
NO	: OK
	:
	:
	:
02	: OK
PRESSURE	: OK
TH GAS	: OK
PT AMB.	: OK
T1 EXT	: OK
T3 EXT	: OK
NTC	: OK
BATTERY	: OK
U/I 1 EXT	: OK

6.6.5 madur Service

This option is for service engineers only. A code is needed to enter the menu - exit with [MENU] key.

6.7 Storing of Results

Since the measured results can be stored in the EEPROM memory, it is possible to read them out later for treatment using the *WINFGA* software. Data can be stored in two separate forms. Up to 30 measurement reports and up to 10 banks from continuous measurements containing a total of 1024 sets of results. Using an averaging time of 30 minutes, this would allow the results of over 21 days of measurements to be stored (please be aware that for measuring sessions of that length a proper gas conditioning system is absolutely necessary)

STORE

- selects the menu *STORE*

STORE	
1	REPORTS →
2	BANKS →
3	DELETE ALL REPORTS →
4	DELETE ALL BANKS →
Store	free used
REPORTS.	28 2
BANKS	7 3
BLOCKS	700 324

Explanation of the table:

- Store* -type of storage
- free* -availability of memory (number of free reports, banks or blocks)
- used* -occupied memory (number of free reports, banks or blocks)



6.7.1 Storing measurement reports

The measurement report contains all the results obtained in a single measurement. It contains either current or averaged values and other user-defined factors such as fuel, footer, header etc. If the report should contain soot measurement results or pressure data, then these measurements must be carried out before storing the report. The report will contain either the current or the averaged results depending on which screen was visible when the storing process was started.

Store REPORTS as follows

 - the measured values are displayed. Do you want to print the displayed values proceed as follows



 - select option . The measured values are stored in a buffer memory

 and  - move the cursor to **REPORTS**

 -select option **REPORTS**

REPORTS	
1	
2	REPORT TABLE →
3	HEADER EDITING →
- HEADER -	
<div style="border: 1px solid black; padding: 5px; width: fit-content; margin: 0 auto;"> 4 - lines free editable </div>	

 (6.7.1.2) - edit header



 and  - move the cursor to **STORE REPORT NO. XX**

 (6.7.1.3) - if all 30 Reports are occupied, -- is displayed instead of a number and it is not possible to store the Report. At least one Report has to be erased before a new one can be stored.

 - the "buffered" data are stored in a Report with the displayed number.

6.7.1.1 Report table

This option allows one to view, print and erase Report contents.

 and  - move the cursor to **REPORT TABLE**

 - select option

REPORT TABLE				
◆01	◆02	◆03	04	05
06	07	08	09	10
11	12	13	14	15
16	17	18	19	20
21	22	23	24	25
26	27	28	29	30

- SHOW
 - ERASE

Reports without [◆] are empty.

- erases the selected Reports

- shows the selected Reports, the following screen **REPORT NO.: XX** is opened

← REPORT NO. : 12	
11: 23.52	16.01.94

4 - lines free editable	

FUEL	
O2R.....:	3 %
AVERAGE TIME:	10 mi n

BOILERPOWER:	40.0 kW
CONSUM :	1.5m3/h
TEMPERATURE:	270 °C

TA: 21 °C	TG: 327 °C
O2 16.72 %	CO2 11.23 %

CO 734 ppm	--- mg/m ³
NO 125 ppm	--- mg/m ³
NOx 145 ppm	--- mg/m ³
COu 940 ppm	

CO rel	--- mg/m ³
NO rel	--- mg/m ³
NOxrel	--- mg/m ³



EXCESS AIR	1.00
STACK LOSS	17.6 %
EFFICIENCY	92.7 %

PRESSURE :	12.34 hPa
SOOT LEVEL:	5

6.7.1.2 Header (Notice) editing

This option allows to edit a notice which can be stored and printed with a Report. The HEADER may have 4 lines of 20 characters.

Measurement site and/or short description of the site are commonly stored in such notes.

-  and  - move the cursor to *HEADER EDITING*
 - select option

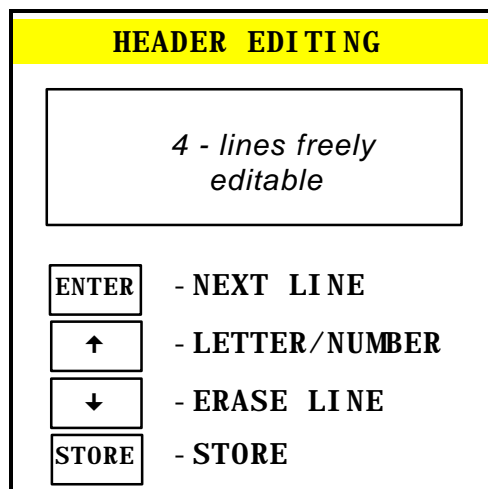



The pictures show screens without text. The screen appears as it was when the report was stored. How the text should be edited is described in section 6.1.4.

This screen can be left at any time using *[MENU]* and *[DATA]*.

6.7.1.3 Erasing Reports

All protocols can be erased in that option.

-  and  - move the cursor to *ERASING REPORTS*
 - select option, the following warning appears

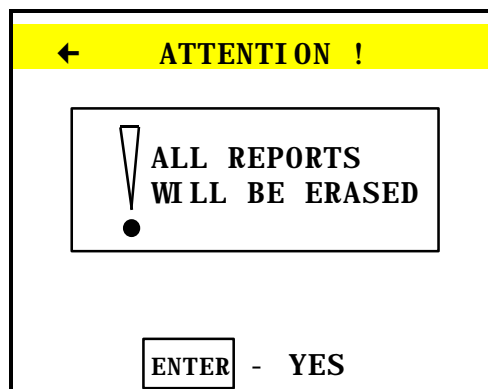

-  - leaves the screen without erasing the Reports

-  - erases all Reports

6.7.2 Continuous storing of results

This type of storing involves the continuous storing of a set of up to 10 measurement results (ONE BLOCK) during a measurement session. The EEPROM can store up to a total of 1024 blocks freely dividable between 10 measuring sessions. These 10 sets of results are known as BANKS. The size of a single bank is only limited by the free memory available. Each bank also contains all necessary information about the measurement (fuel, time, O2R, averaging time etc.). All the results stored are average results for the time set. If the analyser is switched off, and under certain circumstances, the storing of averaged results will stop automatically.

This is signalled by a single long warning tone.



The following table shows the contents of a data block.

LZ	Measured Value	Description
1	TEMP. AMBIENT	These 4 parameters can not be changed, they will be stored in each block
2	TEMP. GAS	
3	SENSOR 1 - O2	
4	SENSOR 2 - CO	
1	SENSOR 3	Out of these parameters, the activated ones will be stored with the Data Block
2	SENSOR 4	
3	TEMP1 EXT	
4	TEMP3 EXT	
5	U/I1 EXT	
6	PRESSURE	



Starting the continuous storing of results (in Banks)

STORE - call the STORE menu

check whether enough free memory is available for the measurement. If not, one or more banks must be erased. The option ERASE ALL BANKS can be used.  (6.7.2.2)

 and  - move the cursor to the option **BANKS**

 - open the option **BANKS**

 and  - move the cursor to the line **STORE**



Set or check the averaging time.  (6.2.5.2)

ENTER - start the storing, the word **ACTIVE** appears



DATA - the measured/calculated values are shown, storage is active

Stopping the continuous storing of results

STORE - call the STORE menu

 and  and-move the cursor to the option **BANKS**



 - open the option **BANKS**

 and  - move the cursor to the line **STORE**

ENTER - storage is stopped, the word **ACTIVE** disappears

6.7.2.1 Banks Table

The option **BANKS TABLE** provides information about the stored Banks.

 and  - move the cursor to the option **BANKS TABLE**

 - select the option **BANKS TABLE**.

BANKS TABLE		
NO.	DATE	SIZE
1	07. 10. 96	73
2	09. 10. 96	180
3	15. 10. 96	124
4		
5		
6		
7		

The column headings have the following meanings:

- No.** - Bank No. from 1 - 10
- Date** -Date (DD.MM.YY) - shows when the storage took place
- Size.** -Bank size - the number of already in the respective Bank stored Blocks

The last bank can be erased in the **BANKS TABLE** screen (the Bank may not be active)

and - move the cursor to the last stored Bank

- erase Bank

6.7.2.2 Erasing Banks

The option **ERASE BANKS** allows to erase all Banks.

and - move the cursor to **ERASE BANKS**

- select the option **ERASE BANKS**

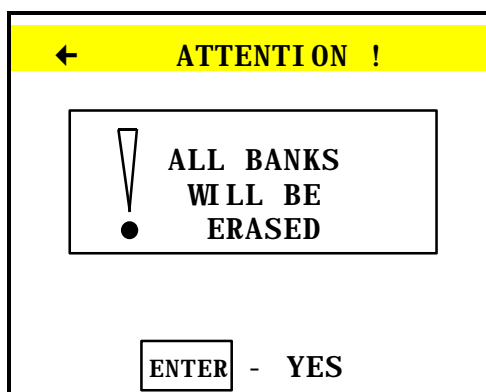

- leaves the screen without erasing **BANKS**

- erases all **BANKS**

6.8 Data-Logger

A data-logger is an instrument that measures variables that have been converted to an electrical signal and stores them for later evaluation.

The inclusion of analogue inputs as shown below and the possibility of storing these results enables the **GA-21 plus** to operate as a data-logger as well.

The analyser is fitted with the following inputs:

- current or voltage (V / mA)
- thermocouples (Ni-CrNi / Pt-RhPt / Fe-CuNi)
- resistance thermometer (Pt100 / Pt500/KTY-2k)

The signals registered by the analogue inputs can either be read from the *DATA* screen or be stored continuously in a bank.

The *WINFGA* software can then be used for further treatment of these results.



The ground (GND) of all analogue inputs is connected to the instrument ground.

6.9 Printer

6.9.1 Printing the contents of a screen

This is not possible for the screen (*DI*). A screen may not be printed whilst data is being entered using the alphanumeric keyboard until this activity has been ended.

PRINT

- prints the contents of a screen

6.9.2 Printing of all results

DATA

- open the first results screen (*DI*)

PRINT

- start a print-out containing all measured results

If the current values are displayed they will be printed; if the averaged values are displayed then these will be printed.

PAPER

- transports the paper

m a d u r GA-21 plus

19. 12. 97 13: 23. 41

FLUE: NATURAL GAS

O2R 3 %

AVERAGE TIME: 30 mi n

POWER : 42. 0 kW

CONSUMPTION.: 8. 4 l/h

TEMP.....: 230 °C

TA 21°C TG 168°C

O2 8. 2% CO2 7. 60 %

CO 100ppm 125mg/m3

NO 46ppm 78mg/m3

NOx 48ppm 123mg/m3

COu 99ppm

CO rel xxxxx mg/m3

NO rel xxxxx mg/m3

NOxrel xxxxx mg/m3

EXCESS AIR...: 2. 2

STACK LOSS...: 14. 5 %

ETA.....: 84. 2 %

ETA*.....: 82. 9 %

PRESSURE..: 16. 21 hPa

SOOT NO...: 4
-----**m a d u r****E L E C T R O N I C S****A- 1220 WIEN, VOITGASSE 4****T: 2584502 F: 258450222**

7 BASIC PRINCIPLES OF CALCULATING RESULTS

7.1 Quantities obtained from direct measurements (O₂, CO, NO, SO₂)

In direct measurements the temperature values and also the concentration of those gas elements which are detected by independent electrochemical sensors are obtained. The electrochemical cell indications are proportional to the volume concentration of the detected elements expressed in [ppm] (parts per million).

The following quantities are obtained by means of direct measurement:

- flue gas temperature T gas and ambient temperature, expressed in [°C]
- volume concentration of CO [ppm]
- volume concentration of NO [ppm]
- volume concentration of SO₂ (or any other optional cell) [ppm]
- volume concentration of O₂ [%]

7.2 Calculating the concentration of carbon dioxide

The volume concentration of carbon dioxide (expressed in [% vol]) is not obtained by direct measurement, but is calculated on the basis of measured oxygen concentration and the CO_{2max} parameter, characteristic for the given fuel.

Formula 1 shows the formula according to which the analyser calculates volume concentration of CO₂:

$$\textcircled{1} \quad \text{CO}_2 = \text{CO}_{2\text{max}} \cdot \left(1 - \frac{\text{O}_{2\text{meas}}[\%]}{20.95\%} \right)$$

7.3 Calculating the concentration of nitrogen oxides NO_x

In addition to nitric oxide NO, combustion gases contain also higher oxides of nitrogen (mainly NO₂) . **GA-21 plus** does not have the nitrogen dioxide sensor in its basic version, only the nitric oxide sensor NO. But it is possible to calculate the NO₂ contents on the basis of the measured NO. It is generally assumed that nitric oxide NO contained in combustion gases makes up about 95% of the total amount of nitrogen oxides NO_x. **GA-21 plus** calculates the total concentration of nitrogen oxides NO_x according to the following formula:

$$\textcircled{2} \quad \text{NO}_x[\text{ppm}] = \frac{\text{NO}[\text{ppm}]}{0.95}$$

If the optional sensor of the **GA-21 plus** analyser is the NO₂ sensor there is no need to calculate the amount of NO₂. Then the NO_x concentration is calculated by the analyser as a simple sum of measured NO and NO₂ concentrations.

$$\textcircled{3} \quad \text{NO}_x[\text{ppm}] = \text{NO}[\text{ppm}] + \text{NO}_2[\text{ppm}]$$

7.4 Concentration of "undiluted" carbon monoxide CO_{undil}

To make the calculation of the carbon monoxide concentration in combustion gases independent of excess air with which the combustion process is conducted, the idea of "undiluted" carbon monoxide CO_{undil} was introduced (it is also called the CO concentration calculated for 0% O₂). The value of CO_{undil} is calculated according to the formula below:

$$\textcircled{4} \quad \text{CO}_{\text{undil}} = \text{CO} \cdot \lambda$$

where:

- CO - volume concentration CO[ppm]
- λ - excess air number

As can be seen, the concentration of "undiluted" CO is the hypothetical concentration that would have been formed if the same amount of carbon monoxide had appeared in combustion gases when burning without excess air (where $\lambda = 1$, so $O_2 = 0\%$).

7.5 Mass concentrations of gas components

GA-21 plus also makes calculations of mass concentration expressed in [mg/m³] from the concentration expressed in [ppm]. Mass concentration of gas elements depends on the gas pressure and temperature. To make comparison of results possible, the idea of standard conditions was introduced, that is standard temperature and pressure values at which the mass concentration of the elements is calculated. In **GA-21 PLUS** system standard conditions of 1000 hPa and 0°C were taken.

The analyser indicates two different values expressed in [mg/m³], they are the so called absolute mass concentration and mass concentration relative to oxygen. These values are often confused - in the next section the way they are calculated and the differences between them are explained.

7.5.1 Absolute mass concentration of gas components

Absolute mass concentration defines how many milligrams of a given gas is contained in 1m³ of combustion gas at standard conditions (1000 hPa, 0°C). The concentration value is calculated from the concentration expressed in [ppm] using the factor A from table 6. The following formula shows how the absolute mass concentration is calculated (here CO concentration):

$$\textcircled{5} \quad \text{CO} \left[\frac{\text{mg}}{\text{m}^3} \right] = \text{CO}[\text{ppm}] \cdot A_{\text{CO}}$$

where:

CO[mg/m³] - absolute CO mass concentration in combustion gas (at standard conditions).

CO[ppm] - absolute CO volume concentration in combustion gas (from measurement).

A_{CO} - correction factor from table 6.

Gas	A $\left[\frac{\text{mg}}{\text{m}^3 \cdot \text{ppm}} \right]$
CO	1.250
NO	1.340
SO ₂	2.860
NO ₂ , NO _x	2.056

Tab. 6: Factors to correct concentration in [ppm] into mass concentration in [mg/m³] (at standard conditions 1000 hPa, 0°C).

Note: mass concentration of nitrogen oxides (NO_x) is calculated by the analyser (according to the standards) using the nitrogen dioxide (NO₂) factor.

Mass concentration calculated by **GA-21 plus** is comparable with the results obtained by other methods (or different types of analysers) only when both calculations have been carried out based on the same standard conditions.

7.5.2 Mass concentrations relative to the concentration of oxygen in combustion gases

As well as absolute mass concentration, the mass concentration relative to oxygen concentration in the combustion gases is calculated. The concentration of a given component in relation to oxygen concentration is expressed by the following formula (as an example for CO value):

$$\textcircled{6} \quad \text{CO}_{\text{rel}} \left[\frac{\text{mg}}{\text{m}^3} \right] = \frac{20.95\% - \text{O}_{2\text{ref}}}{20.95\% - \text{O}_{2\text{meas}}} \cdot \text{CO} \left[\frac{\text{mg}}{\text{m}^3} \right]$$

where:

CO_{rel}	- CO concentration in relation to oxygen expressed in $[\text{mg}/\text{m}^3]$
$\text{O}_{2\text{ref}}$	- reference oxygen, conventional parameter (chosen by selecting fuel or entered independently from keyboard) expressed in [% vol]
$\text{O}_{2\text{meas}}$	- the measured concentration of O_2 in combustion gases expressed in [% vol]
20.95%	- oxygen concentration in pure air
CO	- the measured concentration of CO in combustion gases expressed in $[\text{mg}/\text{m}^3]$ (absolute mass concentration)

Using similar formulae, the concentrations in relation to oxygen concentration of sulphur dioxide SO_2 , nitrogen oxides NO_x and other gases are calculated. The concentration related to oxygen concentration was introduced to make the evaluated concentration independent of the way the combustion process is carried out. The absolute value (expressed in [ppm]) can be lowered artificially in the combustion process with an increase in excess air (large amount of O_2 in combustion gases). It does not have to be a decrease of the total emission. The formula which calculates concentration related to oxygen takes into account the oxygen concentration of the combustion gases, making the results independent of the excess air factor.

The parameter $\text{O}_{2\text{ref}}$ - reference oxygen is a standard value. Standards recommend different values of this parameter for various types of fuel. In the system **GA-21 plus** the value of reference oxygen can be accepted automatically in the process of fuel selection (the so-called *automatic* reference oxygen choice) or entered by the operator from the keyboard (the so-called *manual* selection of reference oxygen). Relative mass concentration calculated from two different measurements are comparable only if the same reference oxygen and the same standard conditions have been used.

Note: If $\text{O}_{2\text{meas}} < \text{O}_{2\text{ref}}$ then relative concentration CO_{rel} calculated from formula $\textcircled{6}$ is less than absolute concentration. In such a case, the analyser replaces the value of relative concentration with the value of absolute mass concentration.

7.6 Calculating combustion parameters

Beside calculating gas component concentrations the analyser calculates some parameters describing the combustion process. The formulas for calculating combustion parameters are empirical formulas. **GA-21 plus** analyser calculates the parameters of the combustion process according to the principles predicted by DIN standards.

The most important parameter is the amount of heat convected by combustion gases to the environment - the so-called chimney loss (stack loss) S_L . Chimney loss is calculated on the basis of empirical formula known as Siegert's formula:

$$S_L = \left(T_{\text{gas}} - T_{\text{amb}} \right) \cdot \left(\frac{A1}{\text{CO}_2} + B \right)$$

where:

S_L	- chimney loss - the percentage of heat produced in combustion process, which is convected with the combustion gases.
T_{gas}	- flue gas temperature
T_{amb}	- the temperature of the boiler inlet air (it is assumed by the analyser to be the ambient temperature)
CO_2	- the calculated (on the basis of oxygen concentration and $\text{CO}_{2\text{max}}$) amount of CO_2 in combustion gases, expressed in [% vol]

A1, B - factors characteristic for a given fuel type (see Table 7)

Based on the calculated chimney loss the analyser estimates the efficiency of the combustion process η (don't confuse it with boiler efficiency)

$$\eta = 100\% - S_L$$

where:

η - combustion efficiency

The above formula assumes that the only quantity decreasing combustion efficiency is chimney loss. Thus it omits incomplete combustion losses, radiation losses etc. Such a simplification is a result of the inability to measure the size of other losses with the gas analyser. Because of this gross simplification in the formula above it should be remembered that the efficiency calculated in this way can not be treated as precise.

However, efficiency calculated like this is very convenient as a comparable parameter when regulating the furnace. The formula, though simplified, reflects precisely the tendencies of efficiency change, thus it is possible to observe whether the efficiency increases or decreases. It is sufficient information for the regulation process.

It is possible to take into account the efficiency reduction caused by incomplete combustion. This loss is represented by a quantity called the loss by incomplete combustion IL. It determines the percentage of energy loss caused by the presence of flammable gases (in this case mainly CO) in the combustion gases. The loss caused by incomplete combustion is calculated on the basis of measured CO concentration in the combustion gases according to the following formula:

$$IL = \frac{\alpha \cdot CO[\%]}{CO[\%] + CO_2[\%]}$$

where:

CO, CO₂ - volume concentrations of CO and CO₂ in the combustion gases

α - the factor specific for a given fuel

Calculating IL enables correction of the previously calculated (formula 8) combustion efficiency. Then the so-called corrected efficiency η^* is calculated:

$$\eta^* = \eta - IL$$

The last combustion parameter calculated by **GA-21 plus** is the excess air factor λ . This factor expresses how many times the amount of air supplied to the boiler is larger than the minimum amount which is necessary to burn the fuel completely. The system calculates the λ factor on the basis of the known CO_{2max} value for the given fuel and the calculated concentration of CO₂ in the combustion gases using the formula:

$$\lambda = \frac{CO_{2max}}{CO_{2meas}}$$

The above formula may be transformed with the use of formula 1 into the form:

$$\lambda = \frac{20.95\%}{20.95\% - O_{2meas}[\%]}$$

7.7 Fuel parameters

The basis for correctly determining the quantities describing the combustion process is the knowledge of fuel parameters. **GA-21 plus** analyser has stored parameters for several standard fuels. Table 7 presents parameters for all the analyser fuels.

No	Fuel type	CO ₂ max [%]	A1	B	α	O ₂ ref [%]	V _{atr} [m ³]	Hu [MJ/UNIT]	Unit
1.	Light oil	15.4	0.5000	0.007	52	3		42.70	kg
2.	Natural gas	11.7	0.3700	0.009	32	3		35.90	m ³
3.	Town gas	13.1	0.3500	0.011	32	3		16.10	m ³
4.	Coke-oven gas	10.2	0.2900	0.011	32	3		17.40	m ³
5.	Liquid gas	14.0	0.4200	0.008	32	3		93.20	m ³
6.	BIO-Diesel	15.7	0.4567	0.005	52	3		41.80	kg
7.	Extra light oil	15.3	0.5900	0	52	3		41.80	kg
8.	Heavy oil	15.9	0.6100	0	52	3		41.00	kg
9.	Coal-tar oil	18.0	0.6500	0	52	3		37.70	kg
10.	Natural gas with fan	12.1	0.4600	0	32	3		35.90	m ³
11.	Town gas with fan	10.0	0.3800	0	32	3		16.10	m ³
12.	Propane with fan	13.7	0.5000	0	32	3		93.20	m ³
13.	Propane	13.7	0.4750	0	32	3		93.20	m ³
14.	Butane with fan	14.1	0.5000	0	32	3		123.80	m ³
15.	Butane	14.1	0.4750	0	32	3		123.80	m ³
16.	Biogas with fan	11.7	0.7800	0	32	3		35.90	m ³
17.	Biogas	11.7	0.7100	0	32	3		35.90	m ³
18.	Mineral coal HV 31.5	18.8	0.6830	0	69	11		31.50	kg
19.	Mineral coal HV 30.3	18.5	0.6720	0	69	11		30.30	kg
20.	Lignite HV 8.2	19.1	1.1130	0	69	11		8.16	kg
21.	Lignite HV 9.4	19.1	0.9880	0	69	11		9.34	kg
22.	Dry wood	19.4	0.6500	0	69	11		15.60	kg

Tab. 7: Parameters of fuels stored in the memory of GA-21 *plus* analyser.

Table 7. shows the following parameters:

CO₂max - the maximum concentration of carbon dioxide in the combustion gas, a quantity specific for a given type of fuel. The parameter determines the amount of carbon dioxide in the combustion gases if the combustion process is carried out with excess air factor l equal 1.

A₁, B - factors which appear in Siegert's empirical formula

α - the factor used to calculate loss caused by incomplete combustion.

It should be assumed

$\alpha = 69$ for solid fuels

$\alpha = 52$ for liquid fuels

$\alpha = 32$ for gaseous fuels

O₂ref - reference oxygen - the parameter used to calculate relative concentrations of components (formula 4). It is a standard quantity. In the table, it has been assumed that as in DIN standards that it is: 11% - for solid fuels and 3% for gaseous and liquid ones.

HV - fuel quality - the amount of energy emitted during complete combustion of 1 kilogram (or 1m³ in case of gas) of fuel.

7.8 The influence of fuel parameters on the accuracy of result calculations

As has already been mentioned, **GA-21 plus** does not measure the concentration of carbon dioxide, but calculates it from the measured oxygen concentration and the $\text{CO}_{2\text{max}}$ parameter. On basis of CO_2 concentration calculated in this way, the chimney loss, combustion efficiency and loss by incomplete combustion are calculated. Obviously, the fuel parameters (especially $\text{CO}_{2\text{max}}$), have a fundamental influence on calculations of combustion processes. The following results calculated by **GA-21 plus** are affected by fuel parameters:

CO_2 contents	- depends on $\text{CO}_{2\text{max}}$
S_L chimney loss	- depends on $\text{CO}_{2\text{max}}$, A1 and B
η and η^*	- depends on $\text{CO}_{2\text{max}}$, A1 and B
IL loss by incomplete combustion	- depends on $\text{CO}_{2\text{max}}$ and α .

As formula shows, the value of the excess air factor is independent of fuel parameters. The calculated results of gas quantities (except CO_2) and the results of temperature measurements and power quantities do not depend on fuel parameters either.

Please note that fuel quality HV does not appear in any formula. This parameter does not influence any measurement result shown by **GA-21 plus**.

8 BLOCK DIAGRAM

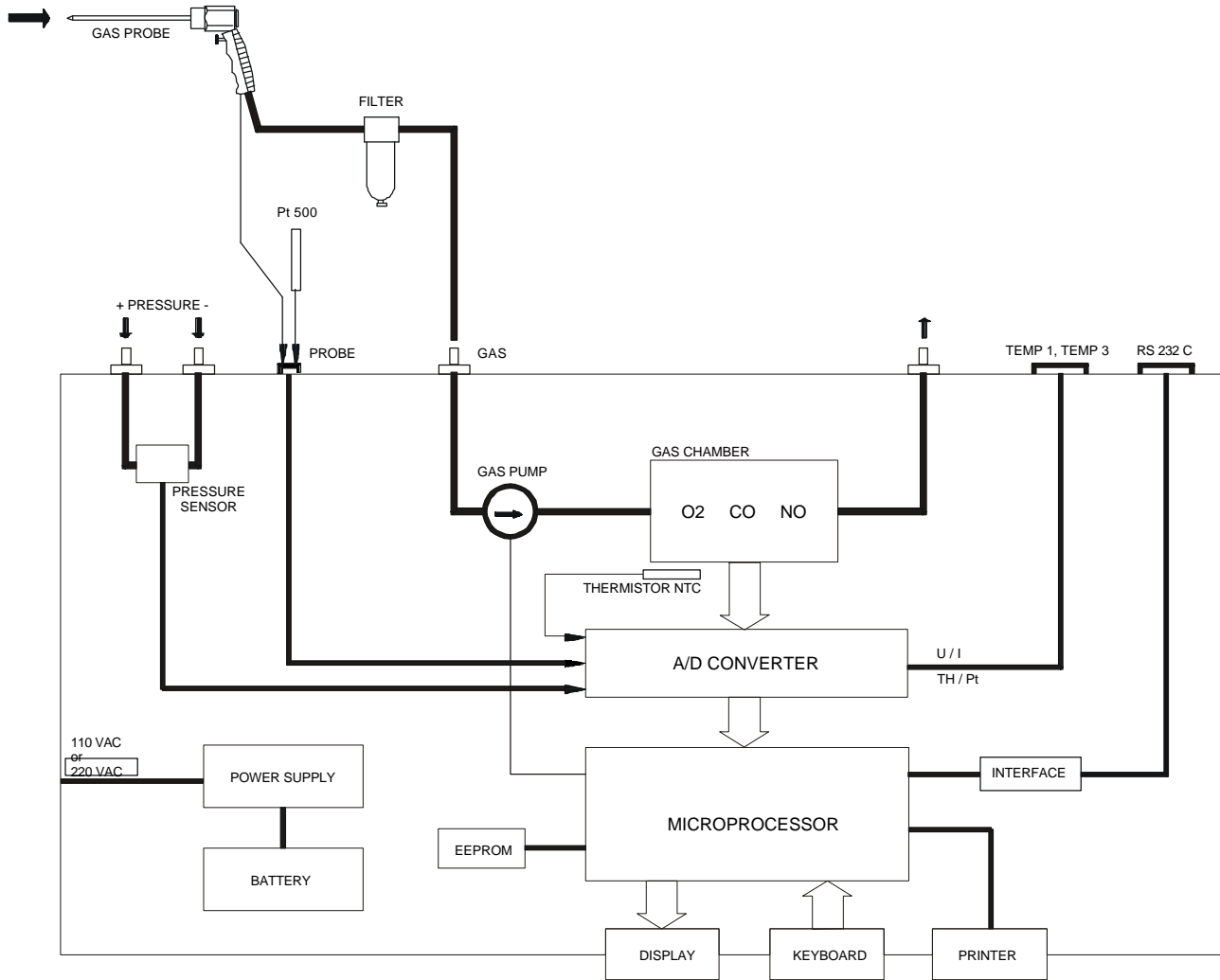

9 FRONT VIEW WITH KEYBOARD

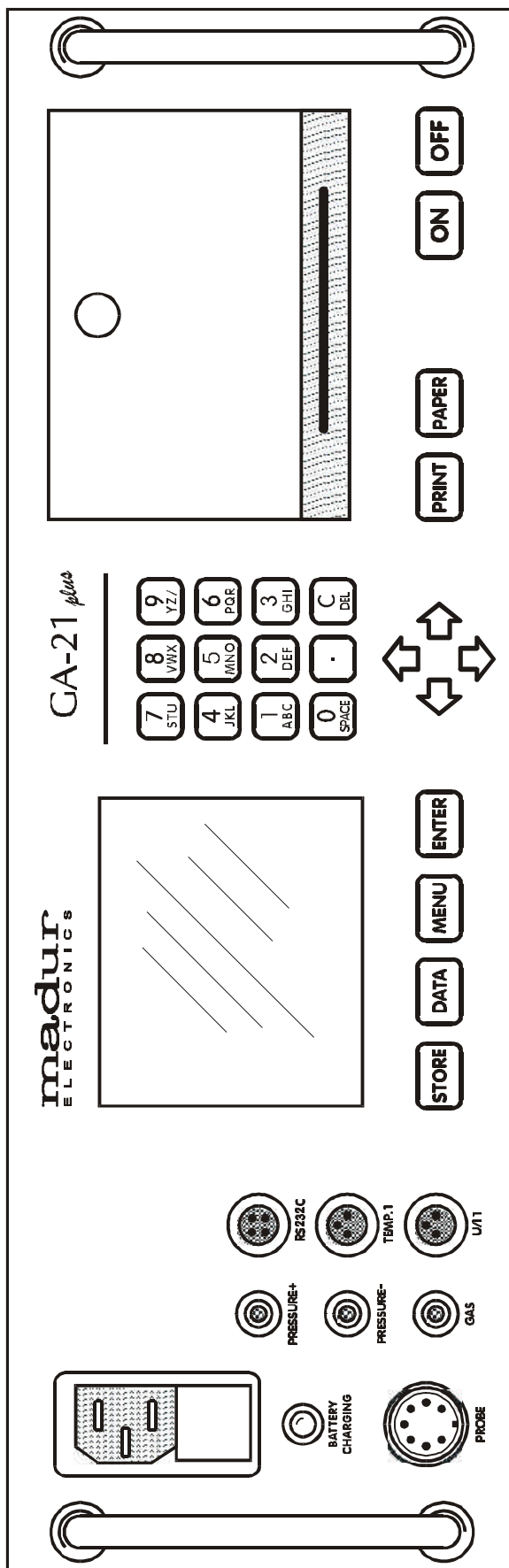

10 MENU STRUCTURE

10.1 Structure of the main menu

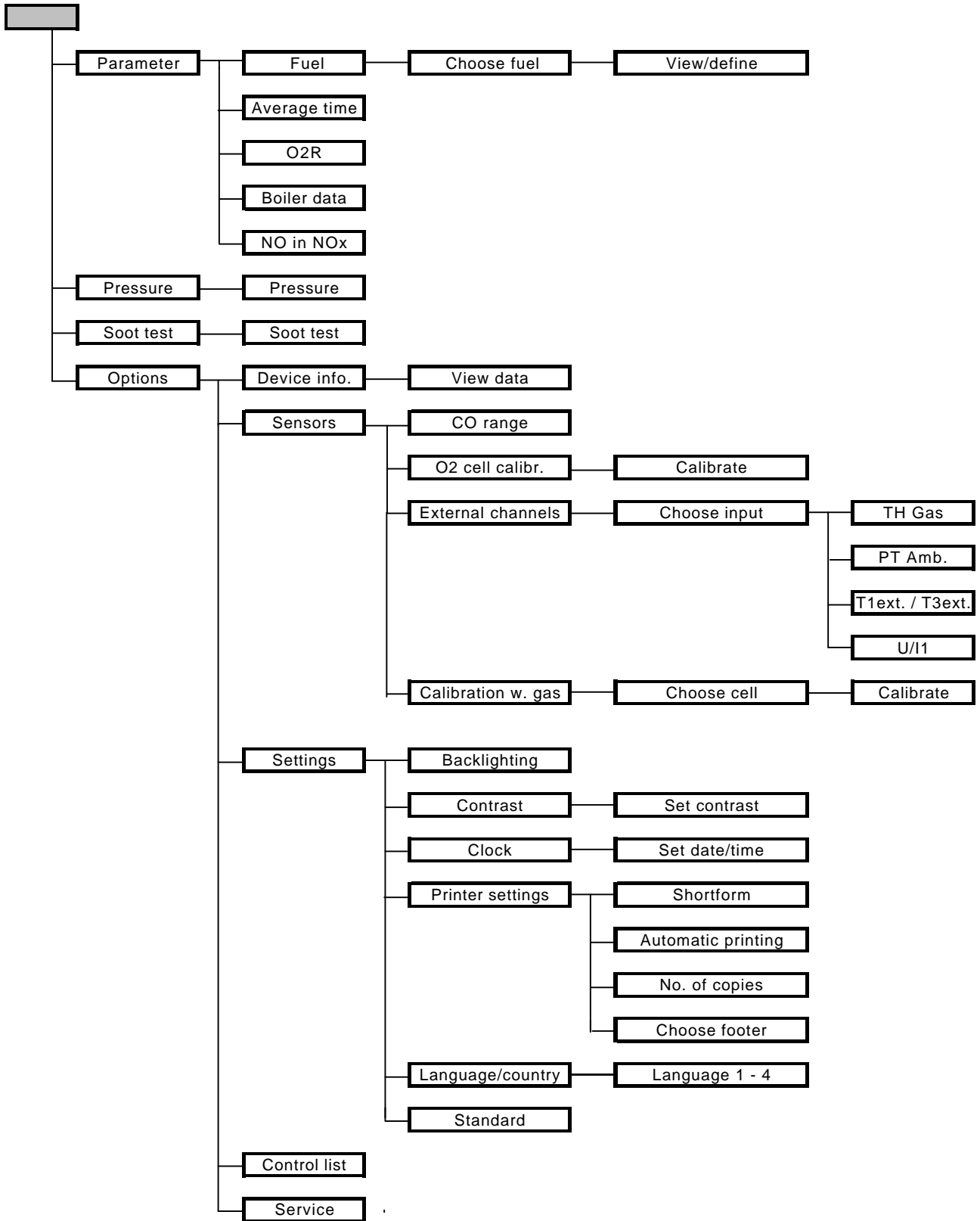

10.2 Structure of the menu STORE

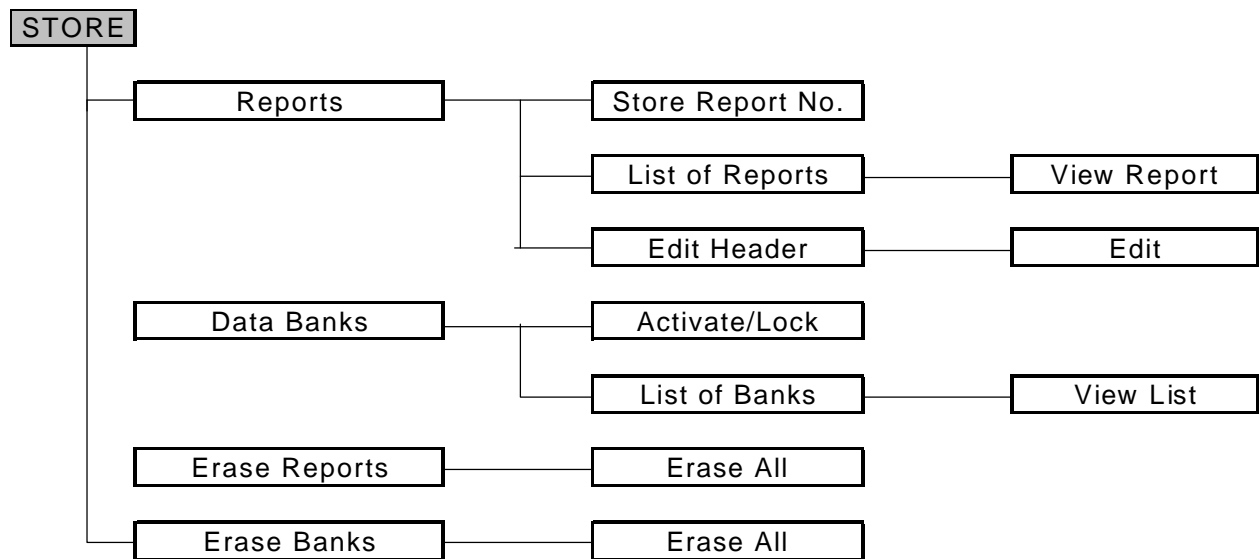

10.3 Structure of the menu DATA

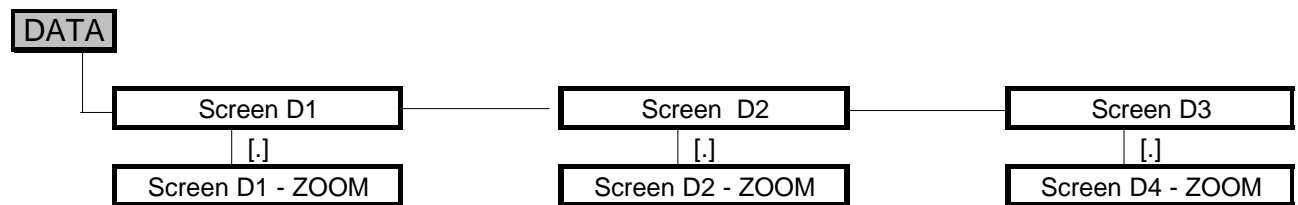

madur[®]
E L E C T R O N I C S

Vienna - Austria